

20V P-Ch Power MOSFET

Feature

- ◇ High Speed Power Switching, Logic Level
- ◇ Enhanced Avalanche Ruggedness
- ◇ Lead Free, Halogen Free

Application

- ◇ Load Switches
- ◇ Hard Switching and High Speed Circuit
- ◇ BLDC Motor

| | | | |
|-------------------------|---------------|-----|----|
| V_{DS} | | -20 | V |
| $R_{DS(on),typ}$ | $V_{GS}=4.5V$ | 37 | mΩ |
| $R_{DS(on),typ}$ | $V_{GS}=2.5V$ | 55 | mΩ |
| $R_{DS(on),typ}$ | $V_{GS}=1.8V$ | 65 | mΩ |
| I_D (Silicon Limited) | | -4 | A |

SOT-23

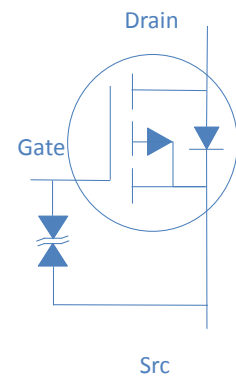
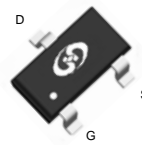

| Part Number | Package | Marking |
|-------------|---------|---------|
| HTJ440P02E | SOT-23 | 2E |

Absolute Maximum Ratings at $T_j=25^\circ\text{C}$ (unless otherwise specified)

| Parameter | Symbol | Conditions | Value | Unit |
|--|----------------|------------------------|------------|------------------|
| Continuous Drain Current (Silicon Limited) | I_D | $T_A=25^\circ\text{C}$ | -4 | A |
| | | $T_A=70^\circ\text{C}$ | -3.5 | |
| Drain to Source Voltage | V_{DS} | - | -20 | V |
| Gate to Source Voltage | V_{GS} | - | ± 8 | V |
| Pulsed Drain Current | I_{DM} | - | -16 | A |
| Power Dissipation | P_D | $T_A=25^\circ\text{C}$ | 1.25 | W |
| Operating and Storage Temperature | T_J, T_{stg} | - | -55 to 150 | $^\circ\text{C}$ |

Absolute Maximum Ratings

| Parameter | Symbol | Max | Unit |
|-------------------------------------|-----------------|-----|--------------------|
| Thermal Resistance Junction-Ambient | $R_{\theta JA}$ | 100 | $^\circ\text{C/W}$ |
| Thermal Resistance Junction-Lead | $R_{\theta JL}$ | 55 | $^\circ\text{C/W}$ |

Electrical Characteristics at $T_J=25^{\circ}\text{C}$ (unless otherwise specified)
Static Characteristics

| Parameter | Symbol | Conditions | Value | | | Unit |
|-----------------------------------|---------------|---|-------|-------|----------|------------|
| | | | min | typ | max | |
| Drain to Source Breakdown Voltage | $V_{(BR)DSS}$ | $V_{GS}=0V, I_D=-250\mu A$ | -20 | - | - | V |
| Gate Threshold Voltage | $V_{GS(th)}$ | $V_{GS}=V_{DS}, I_D=-250\mu A$ | -0.3 | -0.65 | -1.0 | |
| Zero Gate Voltage Drain Current | I_{DSS} | $V_{GS}=0V, V_{DS}=-16V, T_J=25^{\circ}\text{C}$ | - | - | -1 | μA |
| | | $V_{GS}=0V, V_{DS}=-16V, T_J=125^{\circ}\text{C}$ | - | - | -10 | |
| Gate to Source Leakage Current | I_{GSS} | $V_{GS}=\pm 8V, V_{DS}=0V$ | - | - | ± 10 | μA |
| Drain to Source on Resistance | $R_{DS(on)}$ | $V_{GS}=-4.5V, I_D=-4A$ | - | 37 | 44 | m Ω |
| | | $V_{GS}=-2.5V, I_D=-3A$ | - | 55 | 70 | |
| | | $V_{GS}=-1.8V, I_D=-1A$ | - | 65 | 90 | |
| Transconductance | g_{fs} | $V_{DS}=-5V, I_D=-4A$ | - | 14 | - | S |

Dynamic Characteristics

| | | | | | | |
|-------------------------------|--------------|---|---|------|---|----|
| Input Capacitance | C_{iss} | | - | 1059 | - | pF |
| Output Capacitance | C_{oss} | $V_{GS}=0V, V_{DS}=-10V, f=1\text{MHz}$ | - | 132 | - | |
| Reverse Transfer Capacitance | C_{rss} | | - | 127 | - | |
| Total Gate Charge | Q_g | | - | 12.9 | - | nC |
| Gate to Source Charge | Q_{gs} | $V_{DD}=-10V, I_D=-4A, V_{GS}=-4.5V$ | - | 1.8 | - | |
| Gate to Drain (Miller) Charge | Q_{gd} | | - | 3.2 | - | |
| Turn on Delay Time | $t_{d(on)}$ | | - | 15 | - | ns |
| Rise time | t_r | $V_{DD}=-10V, I_D=-1A, V_{GS}=-4.5V,$ | - | 30 | - | |
| Turn off Delay Time | $t_{d(off)}$ | $R_G=6\Omega,$ | - | 35 | - | |
| Fall Time | t_f | | - | 35 | - | |

Reverse Diode Characteristics

| | | | | | | |
|-----------------------|----------|----------------------|---|--|------|---|
| Diode Forward Voltage | V_{SD} | $V_{GS}=0V, I_F=-3A$ | - | | -1.2 | V |
|-----------------------|----------|----------------------|---|--|------|---|

Fig 1. Typical Output Characteristics

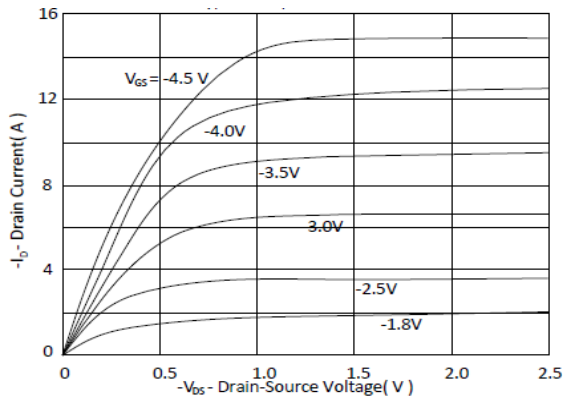

Figure 2. On-Resistance vs. Gate-Source Voltage

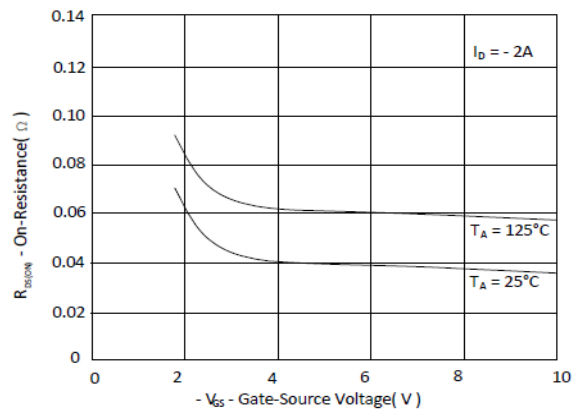

Figure 3. Gate Threshold Voltage v.s. Junction Temperature

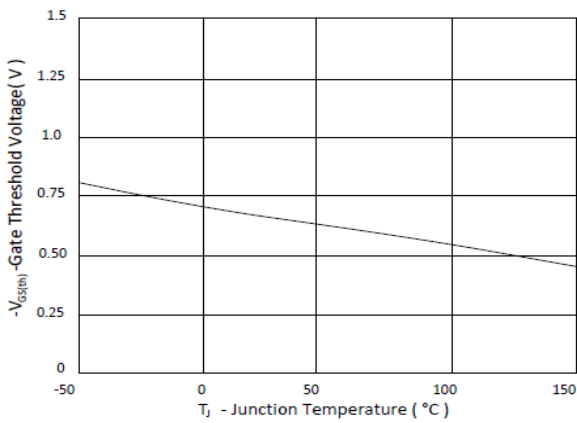

Figure 4. Normalized On-Resistance vs. Junction Temperature

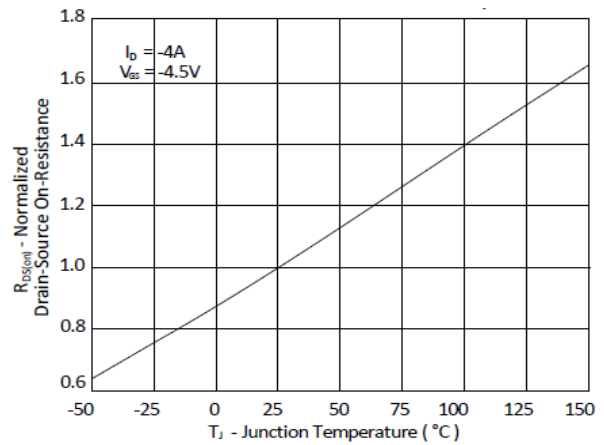

Figure 5. Typical Source-Drain Diode Forward Voltage

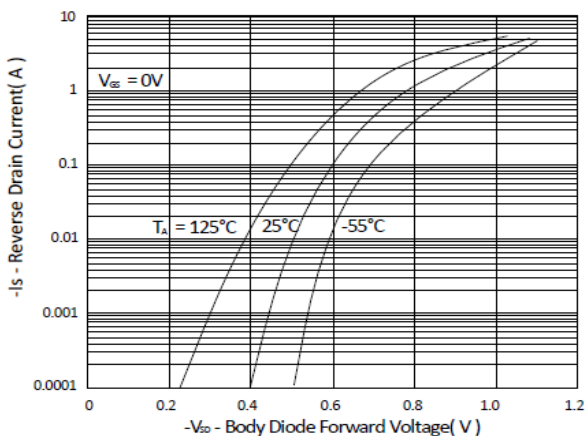

Figure 6. Typical Gate-Charge vs. Gate-to-Source Voltage

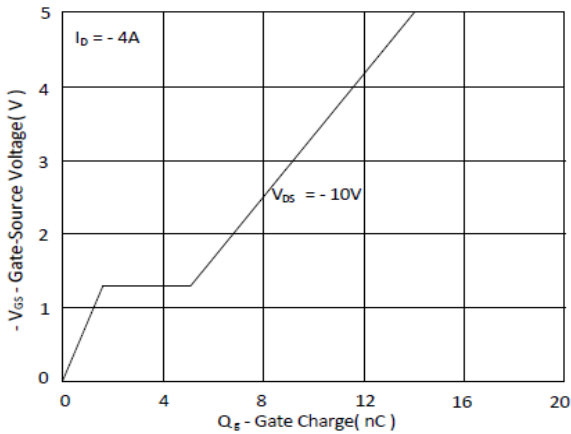

Figure 7. Typical Capacitance vs. Drain-to-Source Voltage

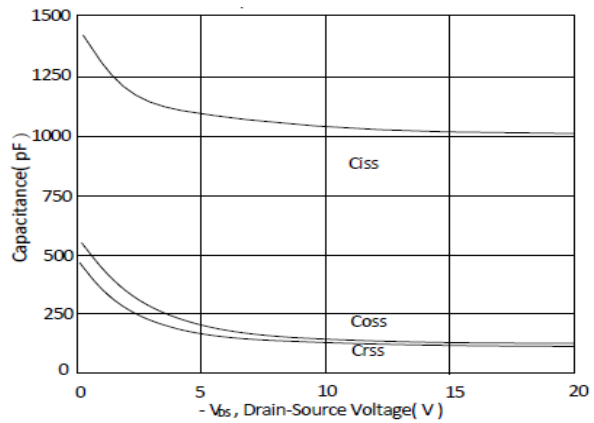

Figure 8. Maximum Safe Operating Area

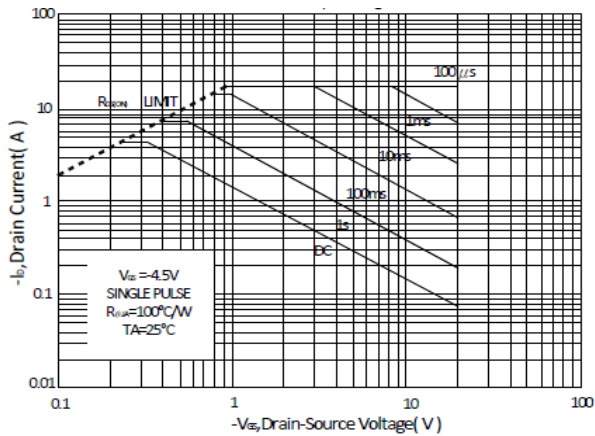

Figure 9. Single Pulse Maximum Power Dissipation

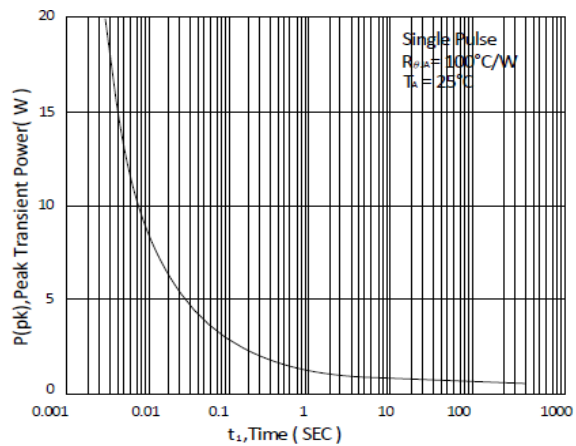
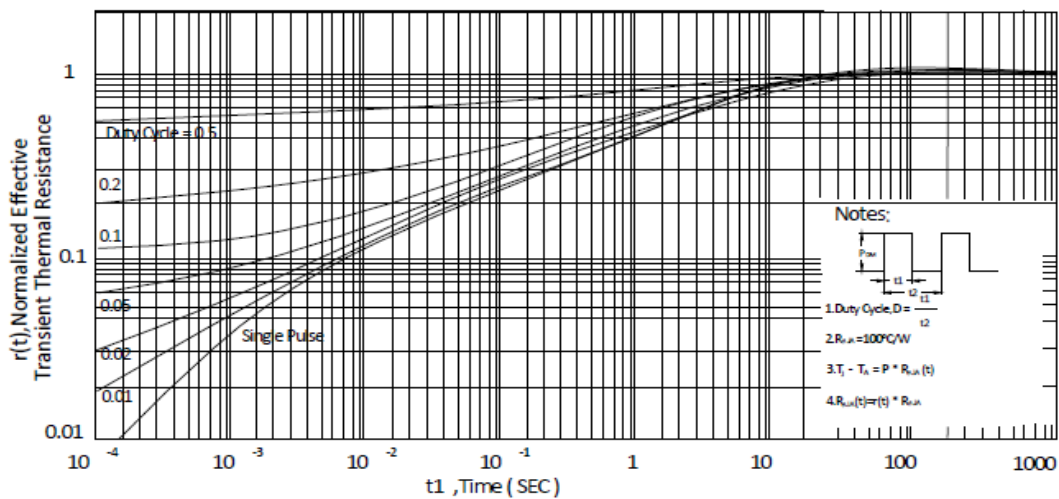
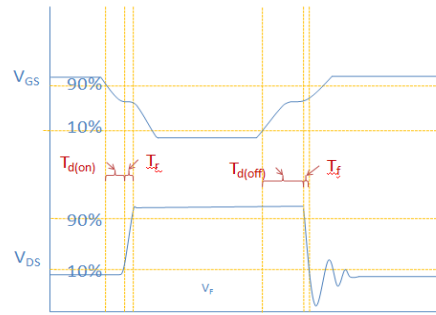
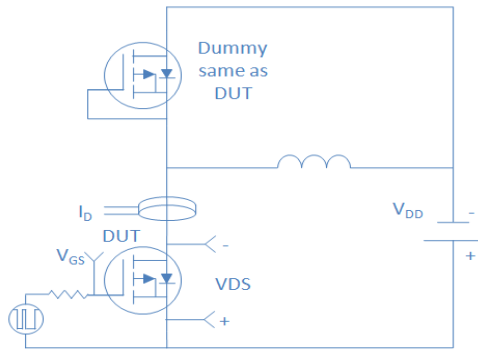

Figure 10. Normalized Maximum Transient Thermal Impedance, Junction-to-Ambient



Inductive switching Test



Gate Charge Test

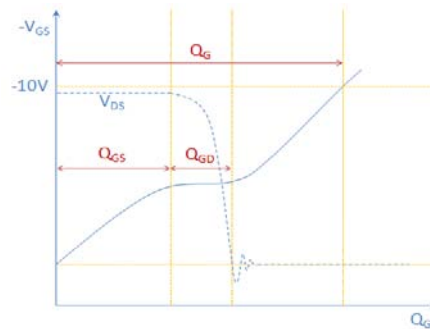
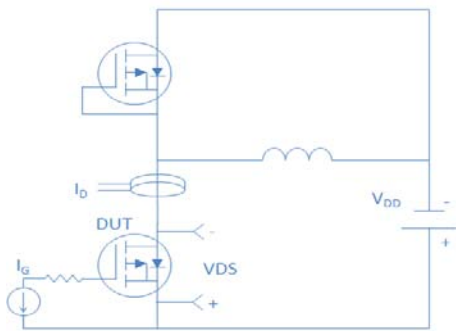

Uclamped Inductive Switching (UIS) Test

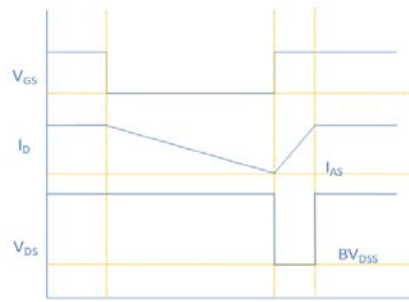
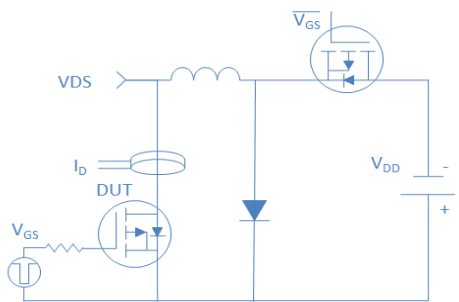

Diode Recovery Test

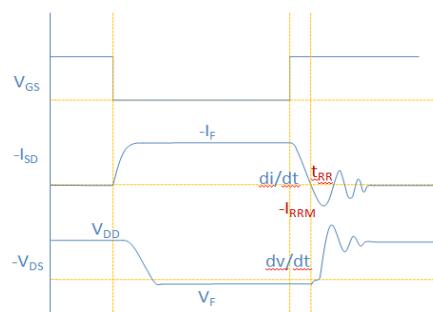
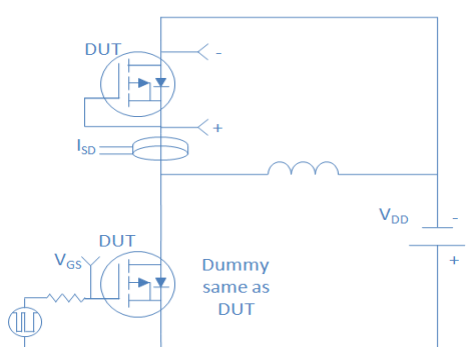

Package Outline

SOT-23, 3leads

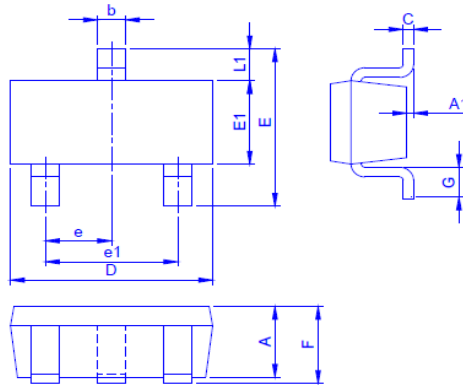

Dimension in mm

| Dimension | A | A1 | A2 | b | C | D | E | E1 | e | e1 | F | G | L1 |
|-----------|------|-----|----|------|-----|-----|-----|-----|------|-----|-----|-----|------|
| Min. | 0.7 | 0 | | 0.35 | 0.1 | 2.8 | 2.6 | 1.5 | 0.9 | | 0.8 | 0.3 | 0.55 |
| Typ. | | | | | | 2.9 | 2.8 | 1.6 | 0.95 | 1.9 | | | |
| Max. | 1.12 | 0.1 | | 0.5 | 0.2 | 3 | 3 | 1.7 | 1 | | 1.2 | 0.6 | 0.65 |